

Model: M200 Prodis Milano M200
 2.0 Metre, Curved Glass, Serve Over Counter

Technical Drawing

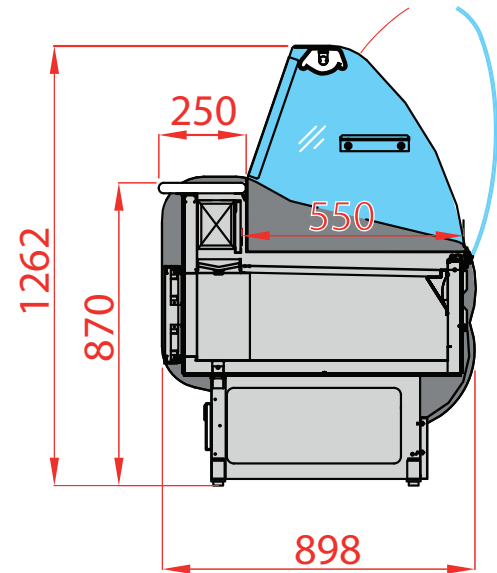

Key Features

Construction

Available Options

- +1°C to +7°C temperature range
- Digital temperature control
- Refrigerated under storage
- Ambient intermediate shelf
- Digital temperature control
- Digital temperature display
- Illuminated display deck
- 550mm deep deck
- Semi ventilated counter
- R404a refrigerant

- Painted steel construction
- Curved glass design

Technical Data

Model	M200
Capacity	332 Litres
Display Area	1.1m ²
External Dimensions	Width = 2000 Depth = 898 Height = 1262
Interior Finish	White
Exterior Finish	Grey / White
Rear Storage Doors	2
Internal Lighting	✓
Internal Lighting Type	Flourescent
Light switch	✓
Light switch position	Externally mounted
Temperature control	Digital
Temperature control position	External
Temperature range	+1° to +7°c
Refrigerant	R404a

Approvals

Available At

Document #

